

## Teste a snodo SI PHS12-DURBAL - PHS12-DURBAL

<https://www.123cuscinetti.ch/cuscinetti-supporti/teste-snodo/si/phs12-durbal>

### PHS12



**Description:** DIN ISO rod end K series. Sliding combination steel / heavy duty bronze.

**female thread:** lubrication required, according to DIN ISO 12240-4, series K

**Rod end body:** surface chromium plated

**Sliding combination:** steel / heavy duty bronze

**Inner ring:** bearing steel, hardened, ground and spherical surface chromium plated

**Outer ring:** heavy duty bronze with lubrication

**Lubrication:** lubrication required

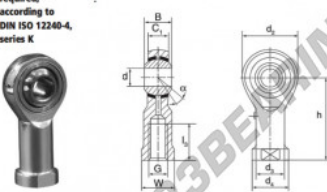

order number	right hand thread	left hand thread	d	G	B	C1	d2	d3	d4
PHS 12			12	M 12	16	12,00	30	17,5	22

type	measurement [mm]				load rating C <sub>0</sub> [kN]	weight [kg]
	l <sub>2</sub> min	W	h	α [°]		
PHS / PHSL 12	22	19	50	13	17,0	0,100

## CARATTERISTICHE DEL PRODOTTO

Marchio	DURBAL
N° Ean13	3663952495101
Diametro interno	12 mm
Diametro esterno	30 mm
Spessore	16 mm
Tipo	SI
Peso	100 g
Il filo	Filetto destro
Lubrificazione	senza
Imballaggio	1

[contatto@123cuscinetti.ch](mailto:contatto@123cuscinetti.ch)

CRT4 de Lesquin 60 Rue Du Haut De Sainghin 59273 Fretin FRANCE