

Teste a snodo SI PHS5-DURBAL - PHS5-DURBAL

<https://www.123cuscinetti.ch/cuscinetti-supporti/teste-snodo/si/phs5-durbal>

PHS5



Description: DIN ISO rod end K series. Sliding combination steel / heavy duty bronze.

female thread:
lubrication required, according to DIN ISO 12240-4, series K

Rod end body:
surface chromium plated

Sliding combination:
steel / heavy duty bronze

Inner ring:
bearing steel, hardened, ground and spherical surface chromium plated

Outer ring:
heavy duty bronze with lubrication

Lubrication:
lubrication required

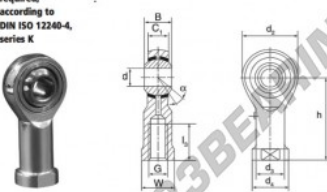

order number	right hand thread	left hand thread	d	G	B	C1	d2	d3	d4
PHS 5			5	M 5	8	6,00	16	8,5	11

type	measurement [mm]				load rating C ₀ [kN]	weight [kg]
	l ₂ min	W	h	α [°]		
PHS / PHSL 5	10	9	27	13	5,7	0,016

CARATTERISTICHE DEL PRODOTTO

Marchio	DURBAL
N° Ean13	3663952494890
Diametro interno	5 mm
Diametro esterno	16 mm
Spessore	8 mm
Tipo	SI
Peso	16 g
Il filo	Filetto destro
Lubrificazione	senza
Imballaggio	1

contatto@123cuscinetti.ch

CRT4 de Lesquin 60 Rue Du Haut De Sainghin 59273 Fretin FRANCE