

Teste a snodo SI GIR17-UK-DURBAL - GIR17-UK-DURBAL

<https://www.123cuscinetti.ch/cuscinetti-supporti/teste-snodo/si/gir17-uk-durbal>

GIR17-UK



female thread: maintenance free, according to DIN ISO 12240-4; series E

Description: DIN ISO rod end E series. Made of spherical plain bearing DGE...UK (UK-2RS) pressed into rod end body. Sliding combination steel / bronze-PTFE composite. Bore diameter $d \geq$ size 35 with additional seal on both sides (e.g. DGR... UK-2RS) bore diameter $d \geq$ size 17 additional seal on both sides upon request.

Rod end body: surface zinc plated

Sliding combination: steel / bronze-PTFE fabric

Inner ring: bearing steel, hardened, ground and spherical surface chromium plated

Outer ring: steel body pressed around, outer race lined with bronze-PTFE composite

Lubrication: no lubrication necessary, maintenance free

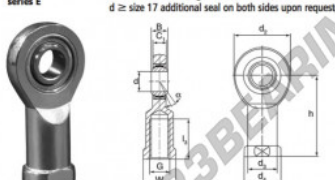

order number	d	G	B	measurement [mm]	d ₂	d ₃	d ₄
GIR 17 UK	17	M 16	14	11,0	46	24,0	30

type	measurement [mm]			α [°]	load rating C ₀ [kN]	weight [kg]
	t ₃ min	h	W			
GIR / GIR 17 UK	34	67	27	10	45,0	0,220

CARATTERISTICHE DEL PRODOTTO

Marchio	DURBAL
N° Ean13	3663952493817
Diametro interno	17 mm
Diametro esterno	46 mm
Spessore	14 mm
Tipo	SI
Peso	220 g
Il filo	Filetto destro
Lubrificazione	senza
Imballaggio	1

contatto@123cuscinetti.ch

CRT4 de Lesquin 60 Rue Du Haut De Sainghin 59273 Fretin FRANCE